

Track System Specification

# MT20SS-55

— MagTrack 20 series



## ◎ Basic Parameters

- Material: AL6063-T5,spraying surface
- Coating: Black (RAL9005)/White (RAL9003)
- Size:  $\phi 55 \times 208 \text{mm}$
- IP grade: IP20
- CCT: Colorful(1500K)
- CRI: 90
- SDCM: <3 Step (ANSI)
- Beam angle: /
- Light efficiency: 57 LM/W
- Input voltage: DC24V-48V
- Lighting direction: /
- Dimming method: Non-dimming,DALI-2,Tuya Bluetooth,CASAMBI
- Application: Indoor
- Certification: CE,UKCA,ROHS,Reach
- Warranty: 5 years

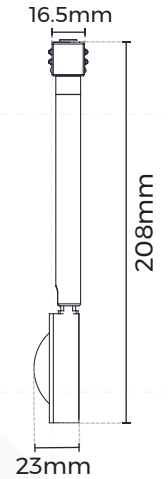

## ◎ Luminaire Parameters

Version	Model	Length	Input Voltage (V)	Max. Current (A)	Type Power (W)	Max. Power (W)	CRI	Beam Angle	CCT	Lumen (LM)
Normal	MT20SS-55	208mm	24-48VDC	0.125-0.063	3.0	3.0	>90	/	Colorful	170

Note:

1. The output data is based on the testing result of Ra90 luminaires;
2. The tolerance of output data can be vary up to 10%;
3. The output data is typical value.

## ◎ Product mechanical data

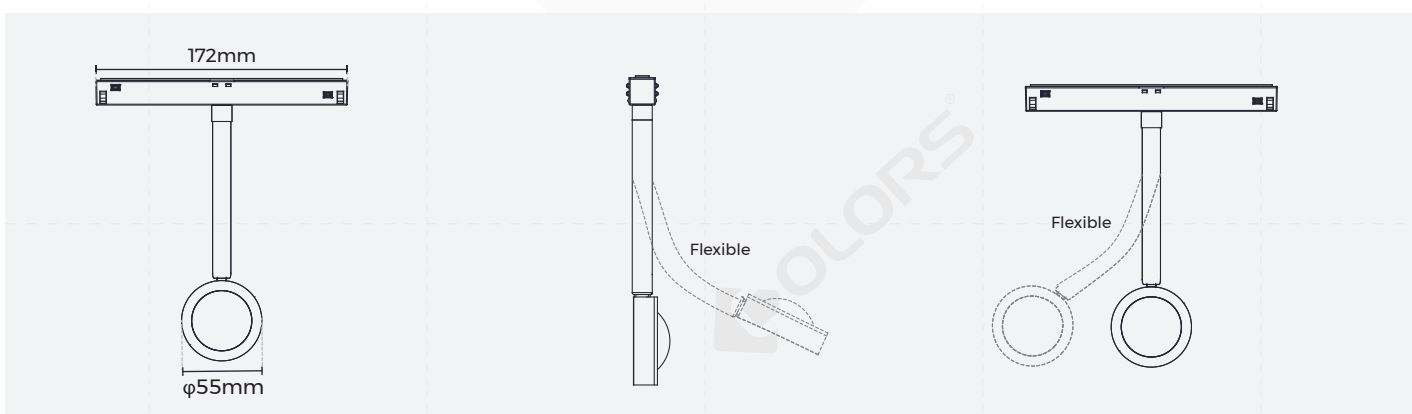

## © MagTrack 20 Application

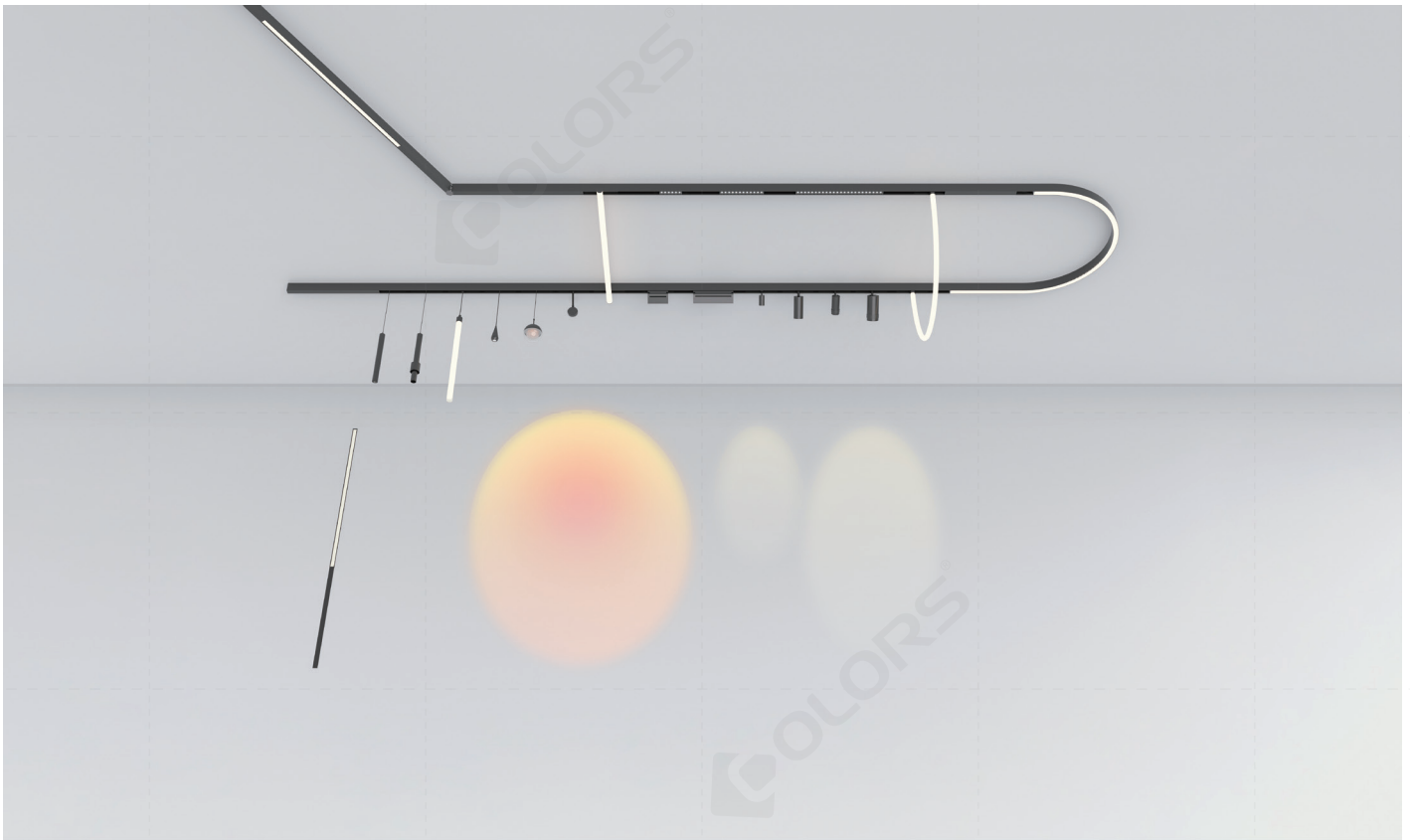

### © Points to note

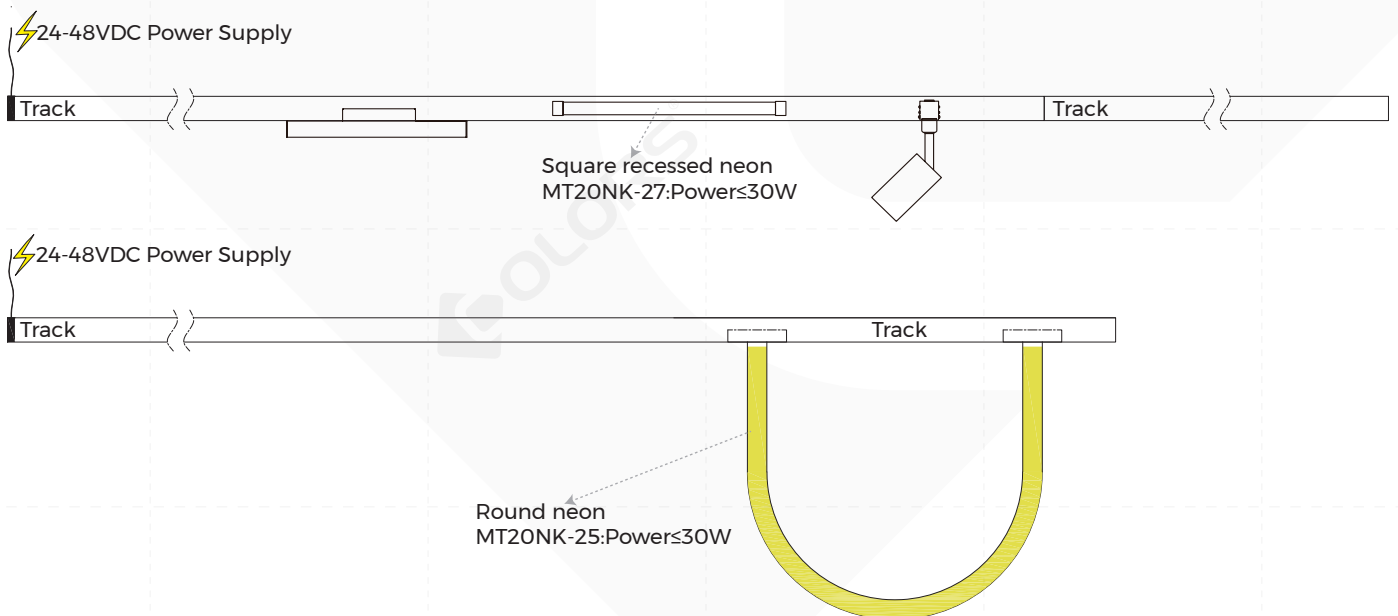

Supplementary power supplies are needed beside the Spotlights module / Decorative module / Linear modular under below one conditions:





1. Power of Square recessed neon MT20NK-27 > 30W
2. Power of Round neon MT20NK-25 > 30W
3. If a DC24V-48V power supply is used to power the track, then only luminaire modules with an input voltage of DC24V-48V can be selected.
4. If a DC48V power supply is used to power the track, then a luminaire module with an input voltage of DC24V-48V or DC48V can be selected.

## ©MagTrack 20 Product Accessories Information

Picture	Name	Model
	Trimless recessed track (9.5mm gypsum board)	TLS-MR2X0(A)
	Trimless recessed track (12.5mm gypsum board)	TLS-MR2X0(B)
	Trimless recessed track (Ordinary batching)	TLS-MR2X0(C)
	Pendant / Ceiling track	TLS-MS2X0
	Pendant / Ceiling track	TLS-MH2X0
	φ800mm 90° Trimless recessed curve track (9.5mm gypsum board)	TLS-MR208A90(A)
	φ1000mm 90° Trimless recessed curve track (9.5mm gypsum board)	TLS-MR210A90(A)
	φ1200mm 90° Trimless recessed curve track (9.5mm gypsum board)	TLS-MR212A90(A)
	φ800mm 90° Trimless recessed curve track (12.5mm gypsum board)	TLS-MR208A90(B)
	φ1000mm 90° Trimless recessed curve track (12.5mm gypsum board)	TLS-MR210A90(B)
	φ1200mm 90° Trimless recessed curve track (12.5mm gypsum board)	TLS-MR212A90(B)
	φ800mm 90° Ceiling/pendant curve track	TLS-MH208A90
	φ1000mm 90° Ceiling/pendant curve track	TLS-MH210A90
	φ1200mm 90° Ceiling/pendant curve track	TLS-MH212A90

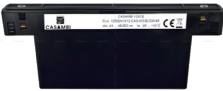
Picture	Name	Model
	Power feeder of track	TLS-M261
	Electrical connector	TLS-M264
	I-shaped electrical connector (Recessed type)	TLS-M265
	I-shaped electrical connector (Surface)	TLS-M266
	End caps	EC-MR20
	End caps	EC-MS20
	End caps	EC-MH20
	Track blind cover	CV-M20FB
	Ceiling accessory	TLS-M271
	Pendant rope set	TLS-M272
	Ceiling screw	CL-01

Picture	Name	Model
	L-shaped corner (Downward)	L90-MR20(A)
	L-shaped corner (Inward)	L90N-MR20(A)
	L-shaped corner (Downward)	L90-MR20(B)
	L-shaped corner (Inward)	L90N-MR20(B)
	L-shaped corner (Downward)	L90-MR20(C)
	L-shaped corner (Inward)	L90N-MR20(C)
	L-shaped corner (Downward)	L90-MS20
	L-shaped corner (Inward)	L90N-MS20
	L-shaped corner (Downward)	L90-MH20
	L-shaped corner (Inward)	L90N-MH20
	L-shaped Adjustable corner (Downward)	L90-MH20(A)
	T-shaped Adjustable corner (Downward)	T90-MH20(A)
	X-shaped Adjustable corner (Downward)	X90-MH20(A)

Picture	Name	Model
	CASAMBI controller	T200EN1812-CAS-XX-BLDAV48
	Magnetic power supply (48V/100W)	MT20-HDRV100H48S-M
	Magnetic power supply (48V/200W)	MT20-HDRV200H48S-M
	48V Constant Voltage Power supply	BN-V48-XXXP

Note:

- 1, Please refer to the accessory list table for detailed parameters.
- 2, Different tracks need to be used with corresponding accessories

## ©MagTrack 20 Product Economical Accessories Information

Picture	Name	Model
	Trimless recessed track (Ordinary batching)	TLS-ECO-MR2X0
	Trimless recessed track (12.5mm gypsum board)	TLS-ECO-MR2X0(A)
	Pendant / Ceiling track	TLS-ECO-MS2X0
	Pendant / Ceiling track	TLS-ECO-MH2X0
	End caps	EC-ECO-MS20
	End caps	EC-ECO-MH20
	L-shaped corner (Inward)	L90-ECO-MS20
	L-shaped corner (Inward)	L90-ECO-MH20
	Pendant rope set	TLS-ECO-M280
	I-shaped electrical connector (Surface)	TLS-ECO-M281

Note:

1,Please refer to the accessory list table for detailed parameters.

2,Different tracks need to be used with corresponding accessories

## ◎ NeonTrack Application

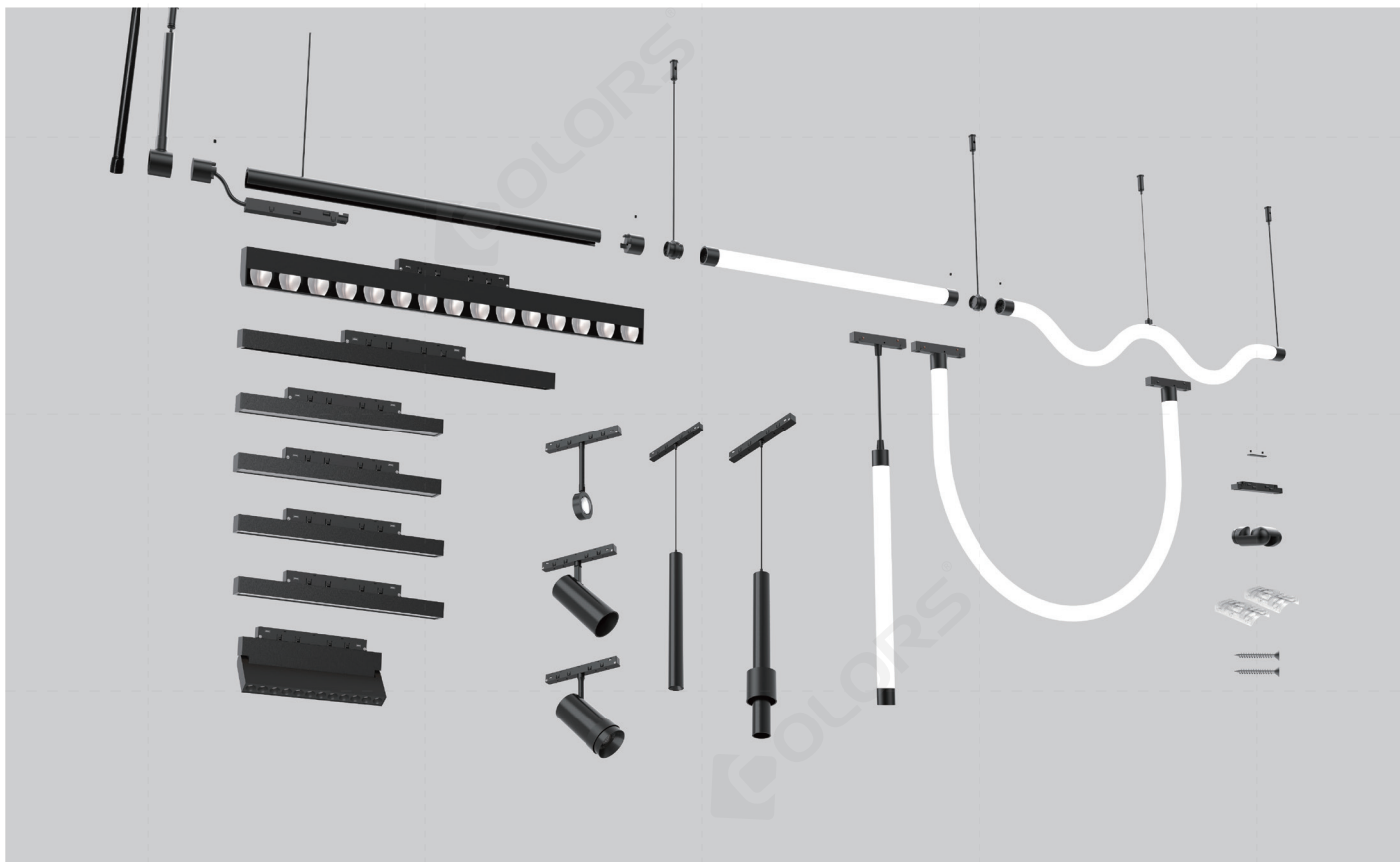

## ◎ Points to note

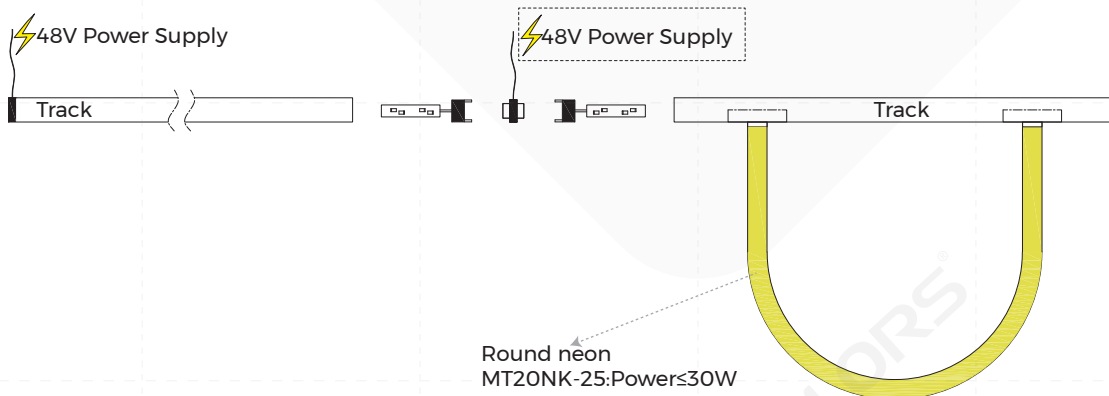
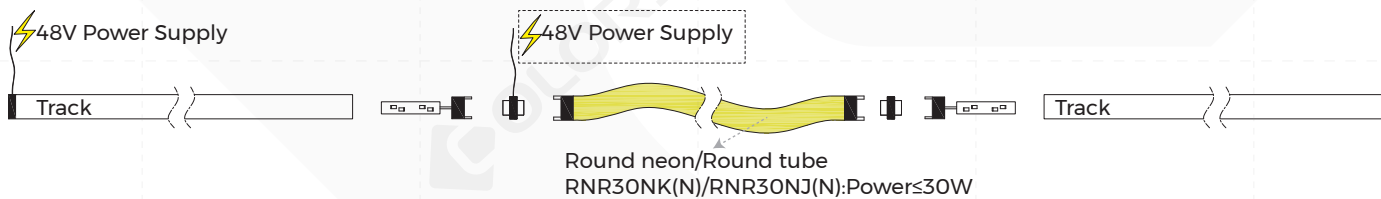
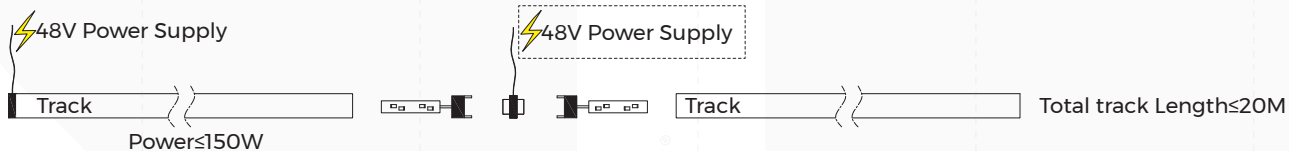





Supplementary power supplies are needed beside the Spotlights module / Decorative module / Linear modular under below one conditions:

1. Load > 150W on the track or Total track length > 20M
2. Power of Round neon/Round tube > 30W

## © NeonTrack Product Accessories Information

Picture	Name	Model
	Round track	TLS-R6X0
	End cap	TLS-R600
	Turned connector	TLS-R860
	Straight connector	TLS-R861
	Power feeder of track	TLS-R862 (N)
	I-shaped electrical connector	TLS-R863 (N)
	Female end cap	TLS-R865
	Ceiling screw	CL-21
	Track pendant rod	PG-I
	Track pendant cable	PN-D

Picture	Name	Model
	Ceiling accessories	CL-18
	Pendant accessories	TLS-R892
	Neon lights Pendant rod (1-2 Meter Adjustable)	TLS-R893
	Neon lights Pendant rod (0.5-1 Meter Adjustable)	TLS-R895
	48V Constant Voltage Power supply	BN-V48-XXXP











Note:

- 1, Please refer to the accessory list table for detailed parameters.
- 2, Different tracks need to be used with corresponding accessories

## ◎Packing

Model	Size (mm/box)	Quantity /box	Quantity /carton	NW (kg/box)	NW (kg/carton)	CW (kg)	Size (mm/carton)
TLS-MT20SS55-039040C-NBX	150*53*263 [5.91"*2.09"*10.35"]	1	30	0.16	4.8	9.5	450*390*340 [17.72"*15.35"*13.39"]

## ◎Model Code

<b>TLS</b>	-	<b>M</b>	<b>T</b>	<b>20</b>	<b>SS</b>	-	<b>03</b>	<b>90</b>	<b>C</b>	-	<b>N</b>	<b>B</b>	<b>X</b>	
														
System TLS Track Light System		Series M: Magnetic Module	Installation T: Track	Track Size 20: 20mm	Type SS: Sunset Spotlight		Size 03: 3-55mm	Type Power 03: 3W	CRI 90: Ra>90	CCT C: Colorful		Dimming Method N: Non-Dimming D: 1-10V Dimming A: DALI Dimming X: No Power	Color B: Black W: White	Diffuser Color X: NO

## ◎Attentions

- 1、 Non-professionals are prohibited from installing, disassembling and repairing the product.
- 2、 Avoid scratching, distortion and irregular bending of the product during installation; otherwise it may cause irreparable damage to the product.
- 3、 Please use professional cutting tools when cutting
- 4、 Do not use any acid or alkaline adhesive to fix products
- 5、 The product is only suitable for indoor dry places, can not be used in outdoor, seaside or wet environment.
- 6、 PC features: Each 10°C rise or drop will make diffuser extend or shrink 0.8mm/m, please confirm before processing and use